



**improve your life**

## **MANUALE D'USO e INSTALLAZIONE**

### **Condizionatore d'aria multisplit**

#### **UNITA' ESTERNE**

**X3MI 105 SH**

**X3MI 120SH**

#### **UNITA' INTERNE**

**X3I 27 HL**

**X3I 35HL**

**X3I 52HL**

**X3I 64HL**

**Leggere attentamente il presente manuale prima di installare e usare il condizionatore e conservarlo per futuri riferimenti.**

# User Notice

- ◆ The total capacity of the indoor units which runs at the same time can not exceed 150% of that of the outdoor units, otherwise, the cooling (heating) effect of each indoor unit would be poor.
- ◆ Switch the main power on 8 hours before starting the unit, helpful for a successful startup.
- ◆ It is a normal phenomenon that the indoor unit fan will still run for 20~70 seconds after the indoor unit receives the “stop” signal so as to make full use of after-heat for the next operation.
- ◆ When the running modes of the indoor and outdoor units conflict, it will be indicated on the display of the wired controller in five seconds and then the indoor unit will stop. In this case, they can back to the normal condition by harmonizing their running modes: the cooling mode is compatible with the dehumidifying mode and the fan mode can go with any other mode. If the supply power fails when the unit is running, then the indoor unit will send the “start” signal to the outdoor unit three minutes later after power recovery.
- ◆ Do not frequently power on/off the unit, otherwise it would cause the compressor, fan, mainboard, electrostatic expansion valve, or other important component damaged, and then make the unit fail.
- ◆ During installation, the communication cable and the power cord must not be twisted together but instead separated with an interval of at least 2cm, otherwise the unit is likely to run abnormally.
- ◆ Cautions for the Debugging and Maintenance Personnel.
- ◆ During debugging and maintenance, prior to the startup of the compressor make sure the heating belt of the compressor has been energized for at least eight hours! Once the compressor is started, it must be guaranteed that it works continuously for at least 30 minutes, otherwise it would be damaged!
- ◆ This appliance can be used by children aged from 8 years and above and persons with reduced physical, sensory or mental capabilities or lack of experience and knowledge if they have been given supervision or instruction concerning use of the appliance in a safe way and understand the hazards involved. Children shall not play with the appliance. Cleaning and user maintenance shall not be made by children without supervision.

- ◆ The appliance shall be installed in accordance with national wiring regulations.
- ◆ If the supply cord is damaged, it must be replaced by the manufacturer, its service agent or similarly qualified persons in order to avoid a hazard.
- ◆ This series outdoor units are matched with the free match D.C. inverter Multi-variable air conditioner indoor unit under the same working conditions exported to European Union.

Correct Disposal of this product	
	<p>This marking indicates that this product should not be disposed with other household wastes throughout the EU. To prevent possible harm to the environment or human health from uncontrolled waste disposal, recycle it responsibly to promote the sustainable reuse of material resources. To return your used device, please use the return and collection systems or contact the retailer where the product was purchased. They can take this product for environmental safe recycling.</p>

R410A(R32/125:50/50):2087.5

# Contents

1 Safety Precautions.....	1
2 Installation Instructions .....	2
2.1 Installation Location and Matters Needing Attention .....	2
2.2 Installation of the Outdoor Unit .....	6
2.3 Connection between Indoor and Outdoor Units .....	8
2.4 Refrigerant Charging and Trial Running .....	11
3 Working Principles of the Unit.....	15
4 Parts and Components of the Unit.....	16
5 Maintenance .....	17
5.1 Check before the Seasonal Use.....	17
5.2 Check after the Seasonal Use.....	17
6 Troubleshooting .....	18
6.1 Check before Contacting Service Center .....	18
6.2 Problem Handling .....	19
6.3 Error Description .....	19
6.4 After-Sales Service.....	26
7 Function Description .....	26
8 Performance Parameters.....	27

# 1 Safety Precautions

Please read this manual carefully before using and operating correctly as instructed in this manual.

Please especially take notice of the following two symbols:



**Warning!** It indicates improper operation which will lead to human casualty or severe injury.



**Caution!** It indicates improper operation which will lead to injury or property damage.



**Warning!**

- ◆ The installation should be committed to the appointed service center, otherwise it will cause water leakage, electric shock or fire etc..
- ◆ Please install the unit in a place where is strong enough to withstand the weight of the unit, otherwise, the unit would fall down and cause injury or death.
- ◆ The drain pipe should be installed as instructed in the manual to guarantee the proper drainage, meanwhile it should be insulated to prevent condensing, otherwise the improper installation would cause water leakage and then wet the household wares in the room.
- ◆ Do not use or place any inflammable, combustible or any noxious substance next to the unit.
- ◆ Under the occurrence of an error (like burning smell etc.), please cut off the main power supply of the unit.
- ◆ Keep good ventilation in the room to avoid oxygen deficit.
- ◆ Never insert your finger or any other object into the air outlet/inlet grille.
- ◆ Please take notice of the supporting frame of the unit to see if it is damaged over the long time period of use.
- ◆ Never refit the unit and contact the sales agent or the professional installation personnel for the repair or relocation of the unit.
- ◆ Non-professional personnel are prohibited to dismantle the electric box owing to the high voltage of the outdoor unit.
- ◆ An all-pole disconnection switch having a contact separation of at least 3mm in all poles should be connected in fixed wiring.

 **Caution!**

- ◆ Before installation, please check if the power supply corresponds with the requirement specified on the nameplate and also check its security.
- ◆ Before using the unit, please check if the piping and wiring are correct to avoid water leakage, refrigerant leakage, electric shock, or fire etc..
- ◆ The main power supply must be earthed to avoid the hazard of electric shock and never connect this earth wire to the gas pipe, running water pipe, lightning rod or phone cable's earth lead.
- ◆ Turn off the unit after it runs at least five minutes, otherwise its service life will be shortened.
- ◆ Do not allow children operate this unit.
- ◆ Do not operate this unit with wet hands.
- ◆ Cut off the main power supply prior to the cleaning of the unit or the replacement of the air filter.
- ◆ When the unit is not to be used for a long time, please cut off the main power supply of the unit.
- ◆ Do not expose the unit to the moist or corrosive circumstances.
- ◆ Never step on the unit or place any object on it.
- ◆ It is suggested to have a power-on test annually.

## 2 Installation Instructions

### 2.1 Installation Location and Matters Needing Attention

The installation of the unit must comply with the national and local safety regulations. The installation quality directly affects the normal use, so the user should not carry out the installation personally, instead, the installation and debugging should be done by technician according to this manual. Only after that, can the unit be energized.

- (1) How to select the installation location for the indoor unit
  - 1) Where there is no direct sunlight.
  - 2) Where the top hanger, ceiling and the building structure are strong enough to withstand the weight of the unit.
  - 3) Where the drain pipe can be easily connected to outside.
  - 4) Where the flow of the air inlet/outlet is not blocked.
  - 5) Where the refrigerant pipe of the indoor unit can be easily led to outside.
  - 6) Where there is no inflammable, explosive substances or their leakage.

- 7) Where there is no corrosive gas, heavy dust, salt mist, smog or moisture.
- (2) How to select the installation location for the outdoor unit
  - 1) The outdoor unit must be installed where the bearing surface is stable and secure enough.
  - 2) The outdoor unit and indoor unit should be placed as close as possible to minimize the length and bends of the refrigerant pipe.
  - 3) Do not install the outdoor unit under the window or between the buildings to prevent the normal running noise entering the room.
  - 4) Where the flow of the air inlet/outlet is not blocked.
  - 5) The outdoor unit should be installed where ventilation is in good condition so that the unit can take in and discharge enough air.
  - 6) Do not install the unit where there are inflammable and explosive substances and where there is heavy dust, salt fog and other severely polluted air.

No air guiding pipe is allowed to be installed at the air inlet/outlet of the outdoor unit. Under the heating mode, the condensate water would drip down from the base frame and would be frozen when the outdoor ambient temperature is lower than 0°C(32°F). Besides, the installation of the outdoor unit should not affect the heat radiation of the unit.



**CAUTION!**

The unit installed in the following places is likely to run abnormally. If unavoidable, please contact the professional personnel at the GREE appointed service center.

- ◆ Where is full of oil.
- ◆ Alkaline soil off the sea.
- ◆ Where there is sulfur gas (like sulfur hot spring).
- ◆ Where there are devices with high frequency (like wireless devices, electric welding devices, or medical equipments).
- ◆ Special circumstances.

(3) Electric Wiring

- 1) The installation must be done in accordance with the national wiring regulations.
- 2) Only the power cord with the rated voltage and exclusive circuit for the air conditioning can be used.
- 3) Do not pull the power cord by force.
- 4) The electric installation should be carried out by the professional personnel as instructed by the local laws, regulations and also this manual.
- 5) The diameter of the power cord should be large enough and once it is

damaged it must be replaced by the dedicated one.

- 6) The earthing should be reliable and the earth wire should be connected to the dedicated device of the building by the professional personnel. Besides, the air switch coupled with the leakage current protection switch must be equipped, which is of enough capacity and of both magnetic and thermal tripping functions in case of the short circuit and overload.

Table 1

Models	Power Supply	Capacity of the Air Switch	Recommended Cord (pieces× sectional area)
GWHD(36)NK3AO	220-240V~ 50Hz	32A	4mm <sup>2</sup> ×3
GWHD(36)NK3BO	220-240V~ 50Hz	32A	4mm <sup>2</sup> ×3
GWHD(42)NK3AO	220-240V~ 50Hz	32A	4mm <sup>2</sup> ×3
GWHD(42)NK3BO	220-240V~ 50Hz	32A	4mm <sup>2</sup> ×3

**Notes:**

- ①. The specifications of the breaker and power cable listed in the table above are determined based on the maximum power (maximum amps) of the unit.
- ②. The specifications of the power cable listed in the table above are applied to the conduit-guarded multi-wire copper cable (like, YJV copper cable, consisting of PE insulated wires and a PVC cable jacket) used at 40°C and resistible to 90°C (see IEC 60364-5-52). If the working condition changes, they should be modified according to the related national standard.
- ③. The specifications of the breaker listed in the table above are applied to the breaker with the working temperature at 40°C. If the working condition changes, they should be modified according to the related national standard.

(4) Earthing Requirements

- 1) The air conditioner is classified into the Class I appliances, so its earthing must be reliable.
- 2) The yellow-green line of the air conditioner is the earth line and can not be used for other purpose, cut off or fixed by the tapping screw, otherwise it would cause the hazard of electric shock.
- 3) The reliable earth terminal should be provided and the earth wire can not be connected to any of the following places.
  - a) Running water pipe.
  - b) Coal gas pipe.
  - c) Sewage pipe.
  - d) Other places where the professional personnel think unreliable.



GWHD(36)NK3AO,GWHD(36)NK3BO

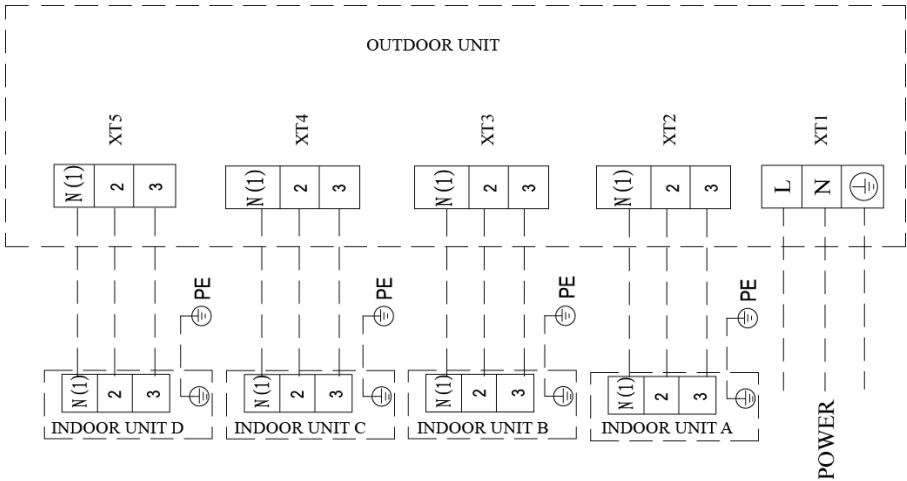

Fig.1

GWHD(42)NK3AO, GWHD(42)NK3BO

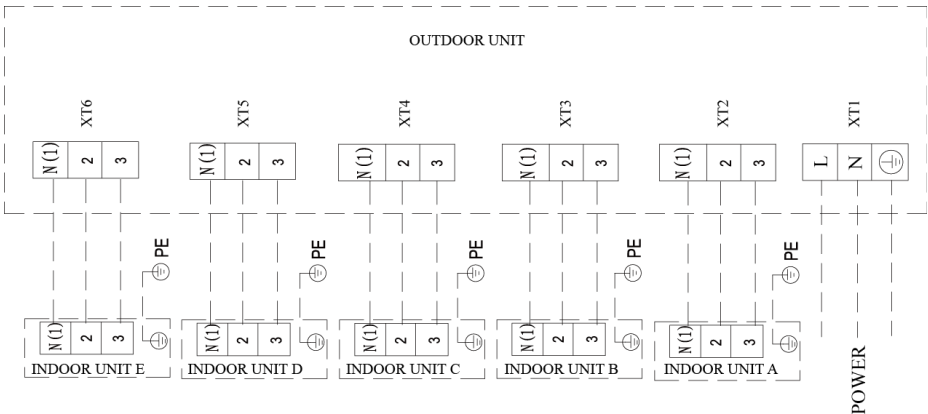

Fig.2

(5) Noise Precautions

- 1) The air conditioning unit should be installed where ventilation is in good condition, otherwise the working capability of the unit would be reduced or working noise would be increased.
- 2) The air conditioning unit should be installed on the base frame which is stable and secure uncouth to withstand the weight of the unit, otherwise it would incur vibration and noise.

- 3) During the installation, a consideration should be taken that the produced hot air or noise should not affect neighbors or surroundings.
- 4) Do not stack obstacles near the air outlet of the outdoor unit, otherwise it would reduce the working capability of the unit or increase the working noise.
- 5) In the event of the occurrence of abnormal noise, please contact the sales agent as soon as possible.
- (6) Accessories for Installation

Refer to the packing list for the accessories of the indoor and outdoor units respectively.

## 2.2 Installation of the Outdoor Unit

### (1) Precautions for the Installation of the Outdoor Unit

The following rules should be followed when the installation location is being considered so as to let the unit run well enough.

- 1) The discharged air from the outdoor unit won't return back and enough space should be left for maintenance around the unit.
- 2) The installation location should be in good condition so that the unit is able to take in and discharge enough air. Besides, make sure there is no obstacle at the air inlet/outlet of the unit. If there is, remove it.
- 3) The unit must be installed where it is secure enough to support the weight of the unit and capable of reducing to some extent noise and vibration to make sure they do not bother your neighbors.
- 4) The designated lifting hole must be used for lifting the unit and protect the unit carefully during lifting to prevent damaging the metal sheet which would result in rusting in future.
- 5) The unit should be installed where there is as little as direct sunlight.
- 6) The unit must be installed where the rain water and defrosting water can be drained.
- 7) The unit must be installed where the unit won't be covered by the snow and won't be affected by rubbish and oil fog.
- 8) Rubber or spring shock absorbers should be used during the installation of the outdoor unit to meet the noise and vibration requirements.
- 9) The installation dimensions should meet the requirement covered in this manual and the outdoor unit must be fixed securely.
- 10) The installation should be carried out by the professionally skilled personnel.

(2) Installation of the Outdoor Unit

1) Outline dimension of the outdoor unit.

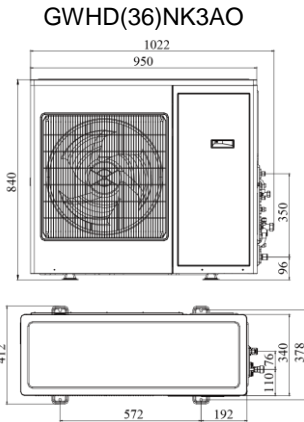

Fig.3

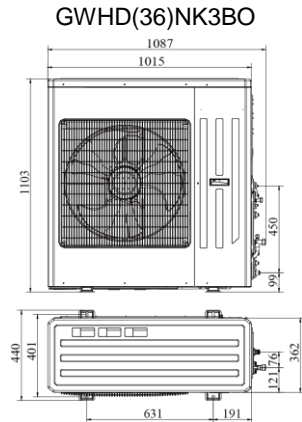

Fig.4

GWHD(42)NK3AO, GWHD(42)NK3BO

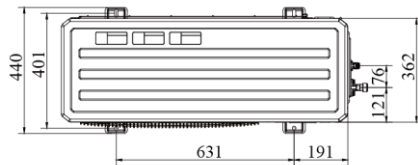
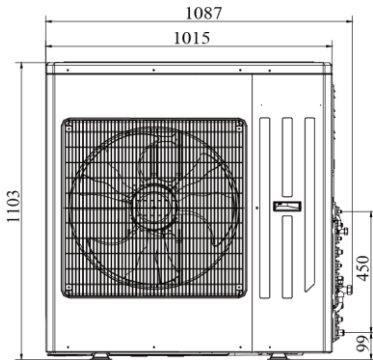

Fig.5

- 2) During the transportation of the outdoor unit, two lifting ropes long enough must be used in four directions and the separation included angle must be less than 40° prevent the center of unit deviating.
- 3) During the installation, M12 screws should be used to fix the support leg and base frame of the unit.
- 4) The unit should be installed on a concrete base frame with a height of 10cm.
- 5) The installation space of the unit should be as required in Fig.6.

Installation Space Requirements of the Outdoor Unit: GWHD(36)NK3AO、

GWHD(36)NK3BO, GWHD(42)NK3AO, GWHD(42)NK3BO

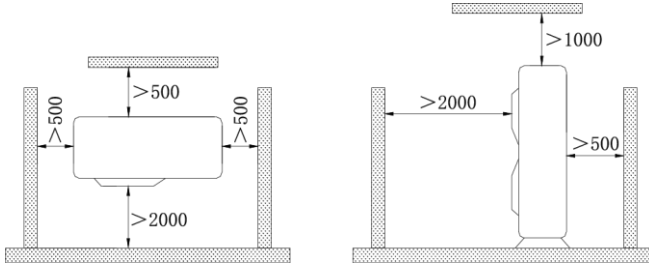

Fig.6

## 2.3 Connection between Indoor and Outdoor Units

### (1) Wiring of the Power Cord

#### CAUTION!

A breaker must be installed, capable of cutting off the power supply for the whole system.

- 1) Open the side plate.
  - 2) Let the power cord go through the rubber ring.
  - 3) Connect the power card to the terminals “L”, “N” and also the earthing bolt, and then connect the wiring terminals “N(1),2,3” of the indoor unit to those of the outdoor unit correspondingly.
  - 4) Fix the power cord with wire clips.
- (2) Energy Level and Capacity Code of the Indoor and Outdoor Units

Table2

	Energy Level	Capacity Code
Indoor Unit	09	25
	12	35
	18	50
	21	60
	24	71
Outdoor Unit	36	100
	42	120

- 1) The outdoor unit with capacity level 36 can drive up to four sets of indoor units, while the outdoor unit 42 can drive up to five.
- 2) The sum of the capacity codes of the indoor units should be among 50%-150% of that of the outdoor unit.

(3) Allowable Length and Height Fall of the Refrigerant Pipe

Table 3

		Allowable Length		Refrigerant Pipe	
		36	42	36	42
Total Length(m)		70	80	L1+L2+L3+ L4	L1+L2+L3+ L4+ L5
Max. Length for Single Unit(m)		20	25	LX	
Max. installation altitude	Outdoor unit and indoor unit	15	15	H1	
	Indoor unit and indoor unit	7.5	7.5	H2	

Table 4 Dimension of the Refrigerant Pipe of the Indoor Unit

Unit: mm

Capacity Level of the Indoor Unit	Gas Pipe	Liquid Pipe
09,12	Φ9.52	Φ6.35
18	Φ12.7	Φ6.35
21,24	Φ15.9	Φ9.52

(4) Piping between the Indoor and Outdoor Units

- 1) Refer to Fig.6 for the moments of torque for tightening screws.
- 2) Let the flare end of the copper pipe point at the screw and then tighten the screw by hand.
- 3) After that, tighten the screw by the torque wrench unit it clatters (as shown in Fig.6).
- 4) The bending degree of the pipe can not be too small, otherwise it will crack. And please use a pipe tube bender to bend the pipe.
- 5) Wrap the exposed refrigerant pipe and the joints by sponge and then tighten them with the plastic tape.

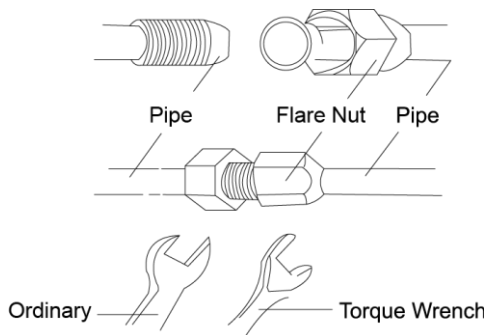

Fig. 7

Table 5 Moments of Torque for Tightening Screws

Diameter	Wall Thickness (mm)	Moment of Torque
Φ6.35mm	≥0.5	15-30(N·m)
Φ9.52mm	≥0.71	30-40(N·m)
Φ12.7mm	≥1	45-50(N·m)
Φ15.9mm	≥1	60-65(N·m)

**⚠ CAUTION!**

- ①. During the connection of the indoor unit and the refrigerant pipe, never pull any joints of the indoor unit by force, otherwise the capillary pipe or other pipe may crack, which then would result in leakage.
- ②. The refrigerant pipe should be supported by brackets, that is, don't let the unit withstand the weight of it.

**⚠ CAUTION!**

For the free match D.C.inverter Multi-variable air conditioner unit, each pipe should be labeled to tell which system it belongs to avoid mistaken inaccurate piping.

- (5) Installation of the Protection Layer of the Refrigerant Pipe
  - 1) The refrigerant pipe should be insulated by the insulating material and plastic tape in order to prevent condensation and water leakage.
  - 2) The joints of the indoor unit should be wrapped with the insulating material and no gap is allowed on the joint of the indoor unit, as shown in Fig.8.

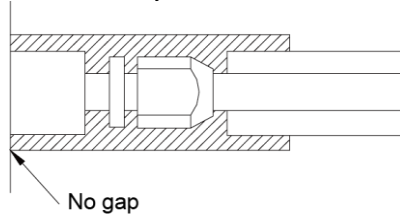

Fig. 8

**⚠ CAUTION!**

After the pipe is protected well enough, never bend it to form a small angle, otherwise it would crack or break.

- (6) Wrap the Pipe with Tape
  - 1) Bundle the refrigerant pipe and electric wire together with tape, and separate them from the drain pipe to prevent the condensate water overflowing.
  - 2) Wrap the pipe from the bottom of the outdoor unit to the top of the pipe where

it enters the wall. During the wrapping, the later circle should cover half of the former one.

- 3) Fix the wrapped pipe on the wall with clamps.

### CAUTION!

- ①. Do not wrap the pipe too tightly, otherwise the insulation effect would be weakened. Additionally, make sure the drain hose is separated from the pipe.
- ②. After that, fill the hole on the wall with sealing material to prevent wind and rain coming into the room.

## 2.4 Refrigerant Charging and Trial Running

### (1) Refrigerant Charging

- 1) The refrigerant has been charged into the outdoor unit before shipment, while additional refrigerant still need be charged into the refrigerant pipe during the field installation.
- 2) Check if the liquid valve and the gas valve of the outdoor unit are closed fully.
- 3) As shown in the following figure (Fig.9), expel the gas inside the indoor unit and refrigerant pipe out by the vacuum pump.

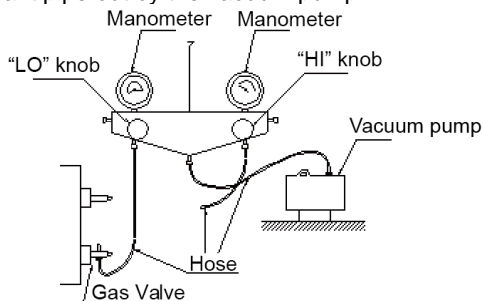

Fig. 9

- 4) When the compressor is not running, charge the R410A refrigerant into the refrigerant pipe from the liquid valve of the outdoor unit (do not do it from the gas valve).
- ### (2) Calculation of the Additional Refrigerant Charging
- 1) Refrigerant Charge in the Outdoor Unit before Shipment

Table 6

Model	GWHD(36)NK3AO	GWHD(36)NK3BO	GWHD(42NK3AO	GWHD(42NK3BO
Refrigerant Charge (kg)	3.6	4.3	4.8	4.8

**Notes:**

- ①. The refrigerant charge mentioned in the table above is not included those charged additionally in the indoor unit and the refrigerant pipe.
  - ②. The amount of the additional refrigerant charge is dependent on the diameter and length of the liquid refrigerant pipe which is decided by the actual yield installation requirement.
  - ③. Record the additional refrigerant charge for future maintenance.
- 2) Calculation of the Additional Refrigerant Charge

If the total refrigerant pipe length (liquid pipe) is smaller than that listed in the table below, no additional refrigerant will be charged.

Table 7

Model	Total Liquid Pipe Length (a+b+c+d+e)
GWHD(36)NK3AO	≤40m
GWHD(36)NK3BO	≤40m
GWHD(42)NK3AO	≤50m
GWHD(42)NK3BO	≤50m

Additional Refrigerant Charge<sub>2</sub>=∑Extra Liquid Pipe Length×22g/m(liquid pipe 1/4").

**Note:**

If the total refrigerant pipe length is larger than that listed in the table above, the additional refrigerant for the extra length of the pipe needs to be charged as per 22g/m.

3) Example : GWHD (42) NK3AO

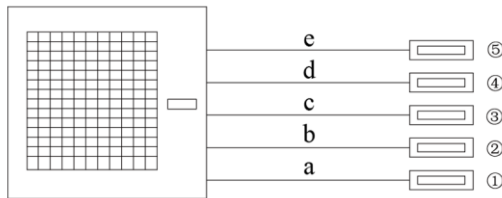

Fig.10

Table 8 Indoor Unit

Serial No.	Model
Indoor Unit⑤	Ducted Type GFH(09)EA-K3DNA1A/I
Indoor Unit④	Ducted Type GFH(09)EA-K3DNA1A/I
Indoor Unit③	Ducted Type GFH(09)EA-K3DNA1A/I
Indoor Unit②	Ducted Type GFH(09)EA-K3DNA1A/I
Indoor Unit①	Ducted Type GFH(18)EA-K3DNA1A/I



Table 9 Liquid Refrigerant Pipe

Serial No.	e	d	c	b	a
Diameter	Φ6.35	Φ6.35	Φ6.35	Φ6.35	Φ9.52
Length	20m	20m	15m	5m	5m

The total length of each liquid refrigerant pipe is:  $e+d+c+b+a=20+20+15+5+5=65\text{m}$ . Thus, the minimum additional refrigerant charge= $(65-50)\times 0.022=0.33\text{kg}$  (Note: no additional refrigerant is needed for the liquid pipe within 50m).

## 4) Additional Refrigerant Charge Record

Table 10 Indoor Unit

No.	Indoor Unit Model	Additional Refrigerant Charge(kg)
1		
2		
.....		
N		
Total		

Table 11 Refrigerant Pipe

Diameter	Total Length(m)	Additional Refrigerant Charge(kg)
Φ15.9		
Φ12.7		
Φ9.52		
Φ6.35		
Total		

## (3) Items to be checked after the Installation

Table 12

Items to be Checked	Possible Errors	Check Results
Has each part and component of the unit been installed securely?	The unit may fall off, vibrate or generate noise.	
Has the gas leakage test been taken?	The cooling (heating) capacity may be poor.	
Is the thermal insulation sufficient?	Dews and water drops may be generated.	
Does the drainage go well?	Dews and water drops may be generated.	
Is the actual power voltage in line with the value marked on the nameplate?	The unit may break down or some components may be burnt out.	

## Free Match D.C.inverter Multi-variable Air Conditioner Outdoor Unit

Are the wiring and the piping correct?	The unit may break down or some components may be burnt out.	
Has the unit been earthed reliably?	There may be a danger of electric shock.	
Does the wire meet the regulated requirement?	The unit may break down or the component may be burnt out.	
Is there any obstacle at the air inlet/outlet of the indoor/outdoor unit?	The cooling (heating) capacity may be poor.	
Have the length of the refrigerant pipe and the refrigerant charge been recorded?	It may be hard to know the exact refrigerant charge.	

### (4) Trial Running

#### 1) Check before the Trial Running

- a) Check if the appearance of the unit and the piping system are damaged during the transportation.
- b) Check if the wiring terminals of the electronic component are secure.
- c) Check if the rotation direction of the fan motor is right.
- d) Check if all valves in the system are fully opened.

#### 2) Trial Running

- a) The trial running should be carried out by the professionally skilled personnel on the premise that all items listed above are in normal conditions.
- b) Let the unit energized and switch the wired controller or the remoter controller to "ON".
- c) The fan motor and compressor of the outdoor unit will run automatically in one minute.
- d) If there is some unusual sound after the compressor is started, turn off the unit for an immediate check.

### 3 Working Principles of the Unit

Schematic Diagram of Free Match Series Inverter Heat Pump Multi VRF System

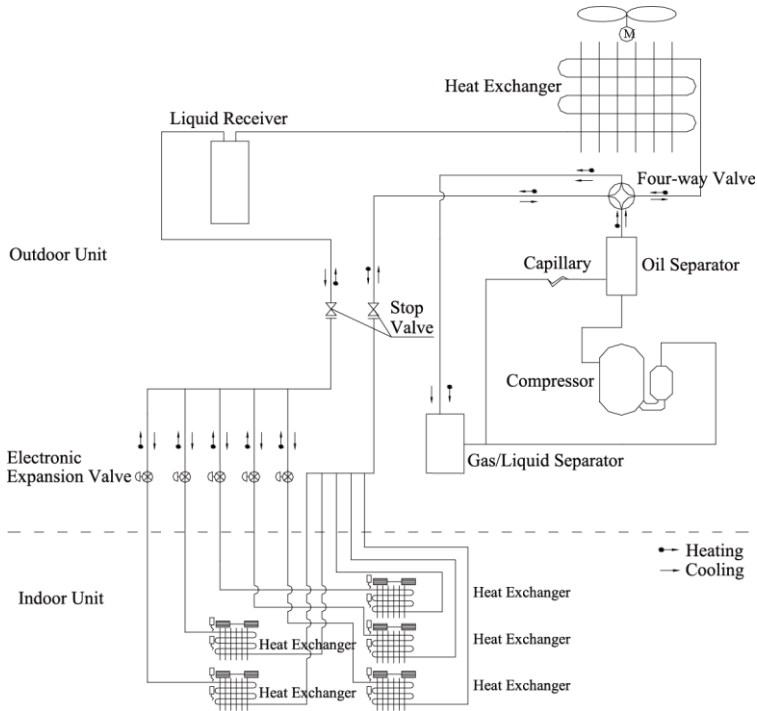

Fig. 11 Schematic Diagram of Free Match Series Inverter Heat Pump Multi VRF System

The outdoor and indoor units start to work once the power is switched on. During the cooling operation, the low temperature, low pressure refrigerant gas from the heat exchanger of each indoor unit gets together and then is taken into the compressor to be compressed into high temperature, high pressure gas, which will soon go to the heat exchanger of the outdoor unit to exchange heat with the outdoor air and then is turned into refrigerant liquid. After passing through the throttling device, the temperature and pressure of the refrigerant liquid will further decrease and then go to the main valve. After that, it will be divided and go to the heat exchanger of each indoor unit to exchange heat with the air which needs to be conditioned. Consequently, the refrigerant liquid becomes low temperature, low pressure refrigerant gas again. Such a refrigeration cycle goes round and round to achieve the desired cooling purpose. During the heating operation, the four-way valve is involved to make the refrigeration cycle run reversely.

The refrigerant radiates heat in the heat exchanger of the indoor unit (so do the electric heating devices) and absorb heat in the heat exchanger of the outdoor unit for a heat pump heating cycle so as to achieve the desired heating purpose.

## 4 Parts and Components of the Unit

System Structure

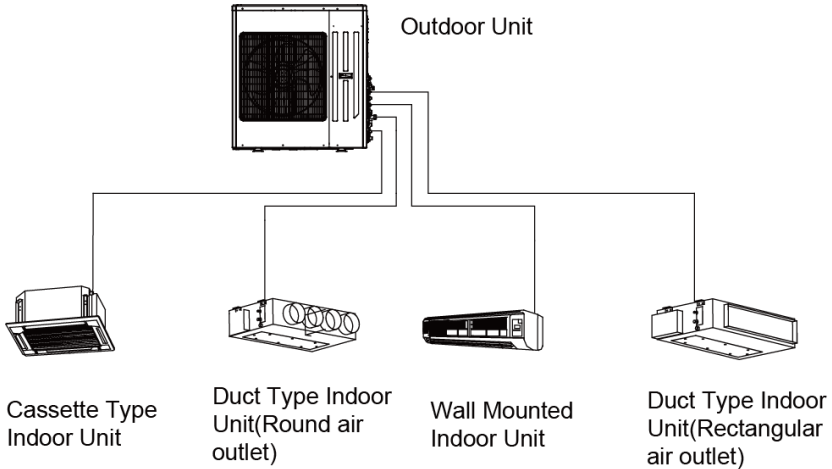

Fig. 12

For the free match D.C.inverter Multi-variable air conditioner unit, one outdoor unit is able to drive up to four or five indoor units which can be cassette type, duct type, wall-mounted or floor ceiling type. Among them, the cassette type and the wall-mounted indoor units should be controlled by the remote controller, while the ducted type can be controlled by either the remote controller or the wired controller. The outdoor unit will run as long as any one indoor unit receives the running command, and all indoor units stop once the outdoor unit is turned off.

## 5 Maintenance

### **WARNING!**

- ①. The unit can only be cleaned after the unit is turned off and the main power is cut off, otherwise it would cause an electric shock hazard.
- ②. Do not dampen the air conditioner, as it would cause an electric shock hazard and never rinse the unit with water in any event.

### **CAUTION!**

- ①. Volatile liquid, like thinner, gasoline etc would damage the appearance of the air conditioning unit. (Only use the soft dry cloth or the wet cloth with neutral detergent clean the outer shell of the air conditioning unit)
- ②. Do not clean the outer shell of the air conditioning unit with more than 45°C hot water to prevent discoloration or deformation.
- ③. Do not dry the air filter screen of the indoor unit on the fire to prevent combustion or deformation.

### 5.1 Check before the Seasonal Use

- (1) Check if the inlet/outlet of the indoor/outdoor unit is clogged.
- (2) Check if the earth lead is earthed reliably.
- (3) Check if the batteries of the remote controller are replaced.
- (4) Check if the air filter screen is installed properly.
- (5) Check if the installation of the outdoor is secure. If there is something abnormal, please contact the GREE appointed service center.
- (6) When restarting the unit which is not used for a long time, switch on the main power supply eight hours ahead, helpful for a successful startup.

### 5.2 Check after the Seasonal Use

- (1) Clean the filter screen and body of the indoor and outdoor units.
- (2) Cut off the main power supply of the air conditioning system.
- (3) Remove the dust and the foreign matters of the outdoor unit.
- (4) In the event of rusting, use the anti-rust paint to stop spreading of rust.

Refer to the Installation and Operation Manual of each indoor unit respectively for detailed maintenance.

## 6 Troubleshooting

### WARNING!

- ①. In the event of abnormal conditions (like, stinky smell), please shut off the main power supply immediately and then contact the GREE appointed service center, otherwise the continuous abnormal running would damage the air conditioning unit and also would cause electric shock or fire hazard etc..
- ②. Do not repair the air conditioning personally but instead contact the professionally skilled personnel at the GREE appointed service center, as the incorrect repair would cause electric shock or fire hazard etc..

### 6.1 Check before Contacting Service Center

Please check the following items before contacting the maintenance serviceman.

Table 13

Conditions	Causes	Corrective Actions
The unit does not run	Broken fuse or opened breaker	Change the fuse or close the breaker
	Power off	Restart the unit when power on
	Power supply plug is loose	Plug the power supply properly
	Insufficient batteries voltage of the remote controller	Change new batteries
	Remoter controller out of the control scope	Keep the control distance within 8 meters
The unit stops soon after it starts	Clogged inlet/outlet of the indoor/outdoor unit	Clear the obstacle
Cooling/Heating is abnormal	Clogged inlet/outlet of the indoor/outdoor unit	Clear the obstacle
	Improperly set temperature	Adjust the setting of the remote or wired controller
	Too low set fan speed	Adjust the setting of the remote or wired controller
	Improper airflow direction	Adjust the setting of the remote or wired controller
	Opened door and window	Close the door and window
	Direct sunlight	Hang a curtain or blinds over the window
	Too much people in the room	
	Too much heat sources in the room	Reduce the heat sources
	Dirty filter screen	Clean the filter screen

**Note:**

If the air conditioner still runs abnormally after the above check and handling, please contact the maintenance serviceman at the local appointed service center and also give a description of the error occurred as well as the model of the unit.

## 6.2 Problem Handling

The conditions listed below are not classified into errors.

Table 14

Conditions		Causes
The unit does not run	When restart the unit soon after it is stopped.	The overload protection switch of the unit let the startup delayed for three minutes.
	As soon as power is on.	The unit will stand by for approximate one minute.
The unit blows out mist	When the cooling operation starts.	The hi-humidity air indoor is cooled quickly.
The unit generates noise	The unit "clatters" as soon as it starts running.	It is the sound generated during the initialization of the electronic expansion valve.
	The unit "swishes" during the cooling operation.	It is the sound when the refrigerant gas runs inside the unit.
	The unit "swishes" when it is started or stopped.	It is the sound when the refrigerant gas stops running.
	The unit "swishes" when it is in and after the running.	It is the sound when the draining system is operating.
	The unit "squeaks" when it is in and after the running.	It is the sound of frication generated by the skin plate etc which swells due to the temperature change.
The unit blows out dust	When the unit restarts after it is not used for a long time.	The dust inside the unit is blown out again.
The unit emits odors	When the unit is running.	The odors absorbed in are blown out again.

## 6.3 Error Description

If some error occurs when the unit is running, the error code will be displayed on the wired controller and the main board  of the outdoor unit. Check for more details about the meaning of each error, as shown in table 15(a), 15(b).

The error codes for duct, cassette and floor ceiling type unit are shown in the following table 15(a):

Table 15(a)

Error Item	Outdoor Unit 88 Display	Indicating LED Flashing Times			88 Display	Wired Controller Display	Error Type
		Running LED	Cooling LED	Heating LED			
High Pressure Protection	E1	Flash once	/	/	E1	E1	Outdoor
Shutdown for Whole Unit Anti-Freeze Protection	E2	Flash twice	/	/	E2	E2	System Error
Low Pressure Protection	E3	Flash 3 times	/	/	E3	E3	Outdoor
High Discharge Temp Protection	E4	Flash 4 times	/	/	E4	E4	Outdoor
Communication Error	E6	Flash 6 times	/	/	E6	E6	Outdoor & Indoor
Indoor Unit Water Full Error	E9	/	Flashing	Flashing	E9	E9	Indoor
Refrigerant Recovery Mode	Fo	Quick Flashing	Quick Flashing	/	Fo	Fo	Special Mode
Outdoor Ambient Temp Sensor Error	F3	/	Flash 3 times	/	F3	F3	Outdoor
Outdoor Mid-Coil Temp Sensor Error	F4	/	Flash 4 times	/	F4	F4	Outdoor
Outdoor Discharge Air Temp Sensor Error	F5	/	Flash 5 times	/	F5	F5	Outdoor
Oil Return for Cooling	F7	/	/	/	/	/	Special Mode
Forced Defrosting	H1	Quick Flashing	/	/	H1	H1	Special Mode
Oil Return for Heating or Defrosting	H1	/	/	Flash once	H1		Special Mode
Compressor Overheat Protection	H3	/	/	Flash 3 times	H3	H3	Drive Error
IPM Protection	H5	/	/	Flash 5 times	H5	H5	Drive Error
Motor Desynchronizing	H7	/	/	Flash 7 times	H7	H7	Drive Error
PFC Error	Hc	/	/	Flash 6 times	Hc	Hc	Drive Error
Startup Failure	Lc	/	/	Flash 11 times	Lc	Lc	Drive Error



Free Match D.C.inverter Multi-variable Air Conditioner Outdoor Unit

DC Fan motor Error	LA	/	/	/	/	/	Outdoor
No indoor fan motor	H6	Flash 11 times	/	/	/	/	Indoor
Compressor phase circuit detection error	U1	/	/	Flash 12 times	/	/	Outdoor
DC link voltage drop error	U3	/	/	Flash 20 times	/	/	Outdoor
Zero detection circuit error	U8	Flash 17 times	/	/	/	/	Outdoor
Phase Loss	Ld	Flash 3 times	Flash 3 times	Flash 3 times	Ld	Ld	Drive Error
Compressor Stalling	LE	Flash 3 times	Flash 3 times	Flash 3 times	LE	LE	Drive Error
Over-Speed	LF	Flash 3 times	Flash 3 times	Flash 3 times	LF	LF	Drive Error
IPM Reset	P0	Flash 3 times	Flash 3 times	Flash 3 times	P0	P0	Drive Error
Compressor Current Protection	P5	/	/	Flash 15 times	P5	P5	Drive Error
Communication Error between the Inverter Drive and the Main Controller	P6	Flash 16 times	/	/	P6	P6	Drive Error
Radiator Temp Sensor Error	P7	/	/	Flash 18 times	P7	P7	Drive Error
Radiator Overheat Protection	P8	/	/	Flash 19 times	P8	P8	Drive Error
AC Contactor Protection	P9	Flash 3 times	Flash 3 times	Flash 3 times	P9	P9	Drive Error
Current Sensor Error	Pc	/	/	Flash 12 times		U1	Drive Error
Sensor Connection Protection	Pd	Flash 3 times	Flash 3 times	Flash 3 times	Pd	Pd	Drive Error
Over Voltage Protection	PH	/	Flash 11 times	/	PH	PH	Drive Error
Low Voltage Protection	PL	/	/	Flash 21 times	PL	PL	Drive Error
Temp Drift Protection	PE	Flash 3 times	Flash 3 times	Flash 3 times	PE	PE	Drive Error
Drive Board Ambient Temp Sensor Error	PF	Flash 3 times	Flash 3 times	Flash 3 times	PF	PF	Drive Error
AC Current Protection	PA	Flash 5 times	/	/	E5	E5	Drive Error

Free Match D.C.inverter Multi-variable Air Conditioner Outdoor Unit

Charging Circuit Error	PU	/	/	Flash 17 times	PU	PU	Drive Error
AC Input Voltage Anomaly	PP	Flash 3 times	Flash 3 times	Flash 3 times	PP	PP	Drive Error
Unit communication error	See Table 16	Flash 6 times	/	/	E6	E6	Indoor
Unit n indoor pipe midway temperature sensor error	See Table 16	/	Flash twice	/	E2	E2	Indoor
Indoor Evaporator Temp Sensor Short/Open-Circuit	See Table 16	/	Flash twice	/	F2	F2	Indoor
(Air Valve) Unit n indoor unit pipe outlet temperature sensor error	See Table 16	/	Flash 22 times	/	b7	b7	Indoor
(Liquid Valve) Unit n indoor pipe inlet temperature sensor error	See Table 16	/	Flash 19 times	/	b5	b5	Indoor
Unit n mode conflict	See Table 16	/	Flash once	/	F1	F1	Indoor
Mode Conflict	See Table 16	Flash 7 times	/	/	E7	E7	Indoor

The error codes for wall mounted type unit are shown in the following table: Table 15(b):

Table 15(b)

Error Item	Outdoor Unit 88 Display	Indicating LED Flashing Times			88 Display	Wired Controler Display	Error Type
		Running LED	Cooling LED	Heating LED			
High Pressure Protection	E1	Flash once	/	/	E1	E1	Outdoor
Shutdown for Whole Unit Anti-Freeze Protection	E2	Flash twice	/	/	E2	E2	System Error
Low Pressure Protection	E3	Flash 3 times	/	/	E3	E3	Outdoor
High Discharge Temp Protection	E4	Flash 4 times	/	/	E4	E4	Outdoor
Communication Error	E6	Flash 6 times	/	/	E6	E6	Outdoor & Indoor

Free Match D.C.inverter Multi-variable Air Conditioner Outdoor Unit

Indoor Unit Water Full Error	E9	Flash 9 times	/	/	E9	E9	Indoor
Refrigerant Recovery Mode	Fo	Flash once	Flash once	/	Fo	Fo	Special Mode
Outdoor Ambient Temp Sensor Error	F3	/	Flash 3 times	/	F3	F3	Outdoor
Outdoor Mid-Coil Temp Sensor Error	F4	/	Flash 4 times	/	F4	F4	Outdoor
Outdoor Discharge Air Temp Sensor Error	F5	/	Flash 5 times	/	F5	F5	Outdoor
Oil Return for Cooling	F7	/	Flash 7 times	/	/	/	Special Mode
Forced Defrosting	H1	Quick Flashing	/	/	H1	H1	Special Mode
Oil Return for Heating or Defrosting	H1	/	/	Flash once	H1		Special Mode
Compressor Overheat Protection	H3	/	/	Flash 3 times	H3	H3	Drive Error
IPM Protection	H5	/	/	Flash 5 times	H5	H5	Drive Error
Motor Desynchronizing	H7	/	/	Flash 7 times	H7	H7	Drive Error
PFC Error	Hc	/	/	Flash 6 times	Hc	Hc	Drive Error
Startup Failure	Lc	/	/	Flash 11 times	Lc	Lc	Drive Error
DC Fan motor Error	LA	Flash 24 times	/	/	LA	LA	Outdoor
Phase Loss	Ld	/	/	/	Ld	Ld	Drive Error
Compressor Stalling	LE	/	/	/	LE	LE	Drive Error
Over-Speed	LF	/	/	/	LF	LF	Drive Error
IPM Reset	P0	/	/	/	P0	P0	Drive Error
Compressor Current Protection	P5	/	/	Flash 15 times	P5	P5	Drive Error
Communication Error between the	P6	Flash 16 times	/	/	P6	P6	Drive Error

Free Match D.C.inverter Multi-variable Air Conditioner Outdoor Unit

Inverter Drive and the Main Controller							
Radiator Temp Sensor Error	P7	/	/	Flash 18 times	P7	P7	Drive Error
Radiator Overheat Protection	P8	/	/	Flash 19 times	P8	P8	Drive Error
AC Contactor Protection	P9	/	/	/	P9	P9	Drive Error
Sensor Connection Protection	Pd	/	/	/	Pd	Pd	Drive Error
Over Voltage Protection	PH	/	Flash 11 times	/	PH	PH	Drive Error
Low Voltage Protection	PL	/	/	Flash 21 times	PL	PL	Drive Error
Temp Drift Protection	PE	/	/	/	PE	PE	Drive Error
Drive Board Ambient Temp Sensor Error	PF	/	/	/	PF	PF	Drive Error
Charging Circuit Error	PU	/	/	Flash 17 times	PU	PU	Drive Error
Unit n communication error	See Table 16	Flash 6 times	/	/	E6	E6	Indoor
Unit n indoor pipe midway temperature sensor error	See Table 16	/	Flash twice	/	E2	E2	Indoor
Indoor Evaporator Temp Sensor Short/Open-Circuit	See Table 16	/	Flash twice	/	F2	F2	Indoor
(Air Valve) Unit n indoor unit pipe outlet temperature sensor error	See Table 16	/	Flash 22 times	/	b7	b7	Indoor
(Liquid Valve) Unit n indoor pipe inlet temperature sensor error	See Table 16	/	Flash 19 times	/	b5	b5	Indoor
Unit n mode conflict	See Table 16	/	Flash once	/	F1	F1	Indoor
Mode Conflict	See Table 16	Flash 7 times	/	/	E7	E7	Indoor

Table 16

Error Code	Error Description	Error Code	Error Description	Error Code	Error Description
13	Unit A indoor unit pipe outlet temperature sensor error	23	Unit B indoor unit pipe outlet temperature sensor error	33	Unit C indoor unit pipe outlet temperature sensor error
14	Unit A indoor pipe inlet temperature sensor error	24	Unit B indoor pipe inlet temperature sensor error	34	Unit C indoor pipe inlet temperature sensor error
15	Unit A indoor ambient temperature sensor error	25	Unit B indoor ambient temperature sensor error	35	Unit C indoor ambient temperature sensor error
16	Unit A mode conflict	26	Unit B mode conflict	36	Unit C mode conflict
17	Unit A anti-freezing protection	27	Unit B anti-freezing protection	37	Unit C anti-freezing protection
41	Unit D communication error	46	Unit D mode conflict	54	Unit E indoor pipe inlet temperature sensor error
42	Unit D indoor pipe midway temperature sensor error	47	Unit D anti-freezing protection	55	Unit E indoor ambient temperature sensor error
43	Unit D indoor unit pipe outlet temperature sensor error	51	Unit E communication error	56	Unit E mode conflict
44	Unit D indoor pipe inlet temperature sensor error	52	Unit E indoor pipe midway temperature sensor error	57	Unit E anti-freezing protection
45	Unit D indoor ambient temperature sensor error	53	Unit E indoor unit pipe outlet temperature sensor error	C5	Jumper terminal error

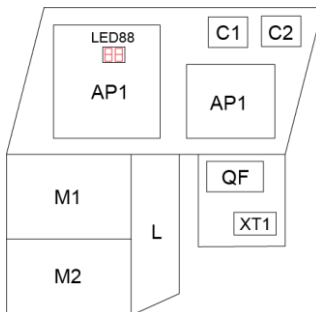

Fig.13 Outdoor Unit: GWHD(36)NK3AO,GWHD(36)NK3BO,GWHD(42)NK3AO

(Note: Refer to the real products for the exact position of each component.)

Once errors are displayed on the controller, please shut off the air conditioning unit and contact the professionally skilled personnel for troubleshooting.

## 6.4 After-Sales Service

If there is any quality or other issue, please contact the GREE after-sales service center.

## 7 Function Description

### **Refrigerant Recovery**

The refrigerant can be recovered from either the indoor unit or the outdoor unit.

From the outdoor unit: it is available to recover the refrigerant from the outdoor unit by pressing “SW3” for a long time period.

From the indoor unit:

When the unit is powered on and runs under the COOL mode, it is available within five minutes to go to refrigerant recovery mode by pressing three times the “LIGHT” button on the wireless controller in three seconds with “F0” displayed.

How to quit the refrigerant recovery:

When the refrigerant recovery has started, it will quit when the “SW3” is pressed down for a long time period or there is a signal from the wireless controller or it has run for ten minutes.

### **Forcible Defrosting**

How to activate this function: when indoor unit runs under the HEAT mode and at 16°C, it will activate the forcible defrosting by pressing the “+” and “-” buttons alternately three times in five seconds.

How to quit this function: the function will quit when the mode of indoor units conflict.

### **Switchover of the Defrosting Modes**

Under the unit is under the “Off” status, if “H1” is not displayed on the wireless controller, then the unit will go to the defrosting mode 1 when it is turned on through the wireless controller.

Under the unit is under the “Off” status, if “H1” is displayed on the wireless controller, the unit will go to the defrosting mode 2 when it is turned on through the wireless controller.

Under the unit is under the “Off” status, it is available to switch over the defrosting mode 1 and defrosting mode 2 by pressing the “Mode” and “Blow” buttons simultaneously.

## 8 Performance Parameters

### Rated Working Conditions of the Air Conditioning Unit

Table 18 Working Temperature Range

	Indoor side state		Outdoor side state	
	Dry bulb temp. °C	Wet bulb temp. °C	Dry bulb temp. °C	Wet bulb temp. °C
Rated Cooling	27	19	35	24
Max. cooling	32	23	48	26
Min. cooling	21	15	18	—
Rated Heating	20	15	7	6
Max. heating	27	—	24	18
Min. heating	20	15	—15	—16

#### Notes:

- ①. The heating/cooling capacity and noise listed below are all measured before the shipment.
- ②. All parameters listed above are measured under the standard working conditions. If there is any change, the parameters marked on the nameplate always prevail.
- ③. The heating capacity of the indoor unit just involves that of the heat pump but apart from that of the auxiliary electric heater.

## **REGOLAMENTO (UE) N. 517/2014 - F-GAS**

L'unità contiene R410A, un gas fluorurato a effetto serra, con potenziale di riscaldamento globale (GWP) = 2087,50. Non disperdere R410A nell'ambiente.

**X3MI 41 SH - Kg. 1,4 = 2,922 Tonn CO<sub>2</sub> equiv.**

**X3MI 56 SH - Kg. 1,6 = 3,34 Tonn CO<sub>2</sub> equiv.**

**X3MI 61 SH - Kg. 2,2 = 4,592 Tonn CO<sub>2</sub> equiv.**

**X3MI 71 SH - Kg. 2,2 = 4,592 Tonn CO<sub>2</sub> equiv.**

**X3MI 80 SH - Kg. 2,4 = 5,01 Tonn CO<sub>2</sub> equiv.**



improve your life

[www.argoclima.com](http://www.argoclima.com)